

Sensepoint Pro

Zareba Product Overview



- **Flammable & toxic gas detector**

- Industry standard 3 wire 4-20mA source output
- Local display and built in alarm relays
- Non-intrusive operation via remote control

Gas		Measuring Range		
Ident	Name	1 [#]	2	3
F	Flammable	0-100%LEL		
O	Oxygen	0-25%VOL		
C	Carbon Monoxide	0-200ppm	0-500ppm	
H	Hydrogen Sulfide	0-50ppm	0-20ppm	0-100ppm
G	Hydrogen	0-1000ppm		

[#] Standard range

- **Approved to ATEX, UL and CSA standards***

- Explosion proof Class 1, Div 1, Groups B, C, D
- EEx II 2 G D EExd IIC T6
- T_{amb} -20°C to +50°C

- **Supplied complete with**

- 3/4"NPT and M20 entries, bracket, weatherproof cover, Allen keys and I.S. remote control



Non-intrusive Operation

Zareba Product Overview



- **Powder blue backlit display**
 - Status at glance with a excellent viewing angle and contrast
 - Gas, range, reading, alarm level and status all shown
- **Fully configurable via I.S. remote control**
 - Simple pushbutton operation common to all products
 - Range, units, alarm levels, energised/de-energised relays
- **Industry standard outputs**
 - 3 wire 4-20mA source
 - 2 x 3A, 240Vac alarm relays (NO/NC, link selectable)
- **Auto-inhibit facility**
 - Programmable 2mA, 4mA, 17.4mA inhibit output
 - 4-20mA and relays clamped while in configuration mode
 - No risk of false alarm to control panel during maintenance
 - May be used with Touchpoint controllers or PLCs
- **Standard wiring configuration**
 - 1 to 1, 2 to 2, 3 to 3 (detector to Touchpoint controllers)
 - Common to all Industrial Detectors in Zareba range

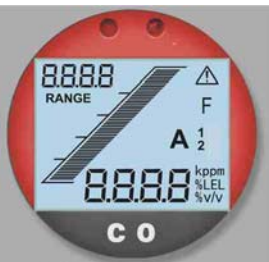

All features on display

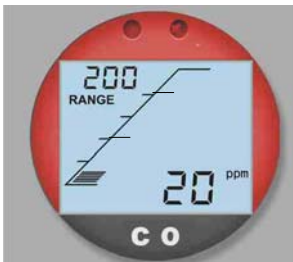

Normal operation display

Convenient Installation

Zareba Product Overview

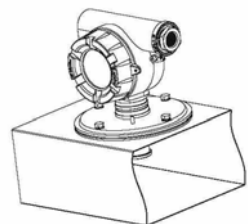
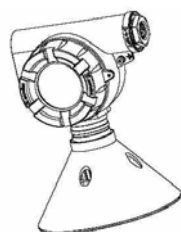
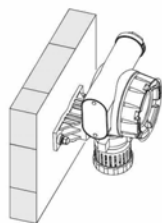
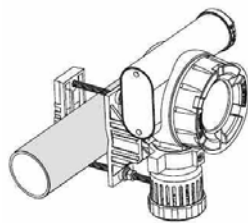

- **Removable display module**
 - Enables unhindered access to terminals
- **Wall mount & pole mount**
 - Bracket included with every unit
- **Collecting cone**
 - Replaces weatherproof cover
 - Includes inlet for remote gassing
- **Duct mount arrangement**
 - Clamping ring for duct
 - Removable plate attaches to ring
 - Detector attaches to the plate
 - External inlet for remote gassing

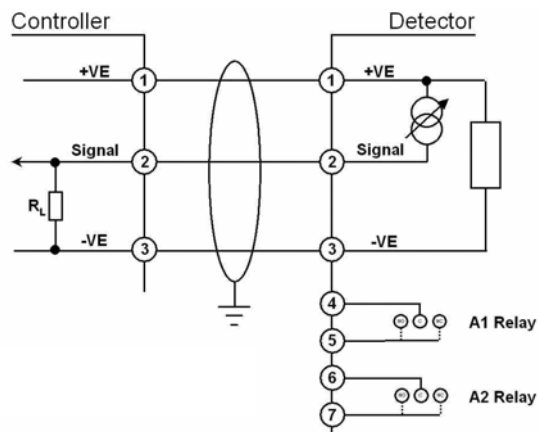

3 Wire 4-20mA (Source) + Relays

**Easy to install, use and
maintain in a variety
of installations**

Modular Construction





- **Plug-in modules simplify maintenance**
 - Display, terminal, sensor modules easy to fit and replace
 - Minimal number of parts required
 - No need for ‘specialist’ knowledge for basic maintenance
- **Sensor replacement**
 - External plug in sensor
 - Colour coded to the detector to minimise error
 - Common to Plus and Pro reduces spares holding
- **Non-intrusive operation**
 - Removes need for ‘hot work’ permit
 - Minimizes time for routine maintenance

Sensepoint Summary

Zareba Product Overview



	<p><u>Sensepoint Pro</u> Most convenient to use Flammable toxic & oxygen Local display & control with auto inhibit Non intrusive set up & configuration</p> <p>Used with PLCs or Touchpoint</p>	<p>Generally... One person for commissioning One person for maintenance</p> <p>No 'Hot work' permit required</p>
	<p><u>Sensepoint plus</u> Time saving Flammable, toxic & oxygen Local transmitter with inhibit function Local intrusive set up & configuration</p> <p>Used with PLCs or Touchpoint</p>	<p>Generally... One person for commissioning One person for maintenance</p> <p>'Hot work' permit required</p>
	<p><u>Sensepoint</u> Low cost Flammable, toxic & oxygen Factory set, no user adjustment for life Disposable, replace sensor end of life</p> <p>Used with Touchpoint controllers</p>	<p>Generally... Two person commissioning Two person maintenance</p> <p>Can be done by one person (takes longer)</p>